

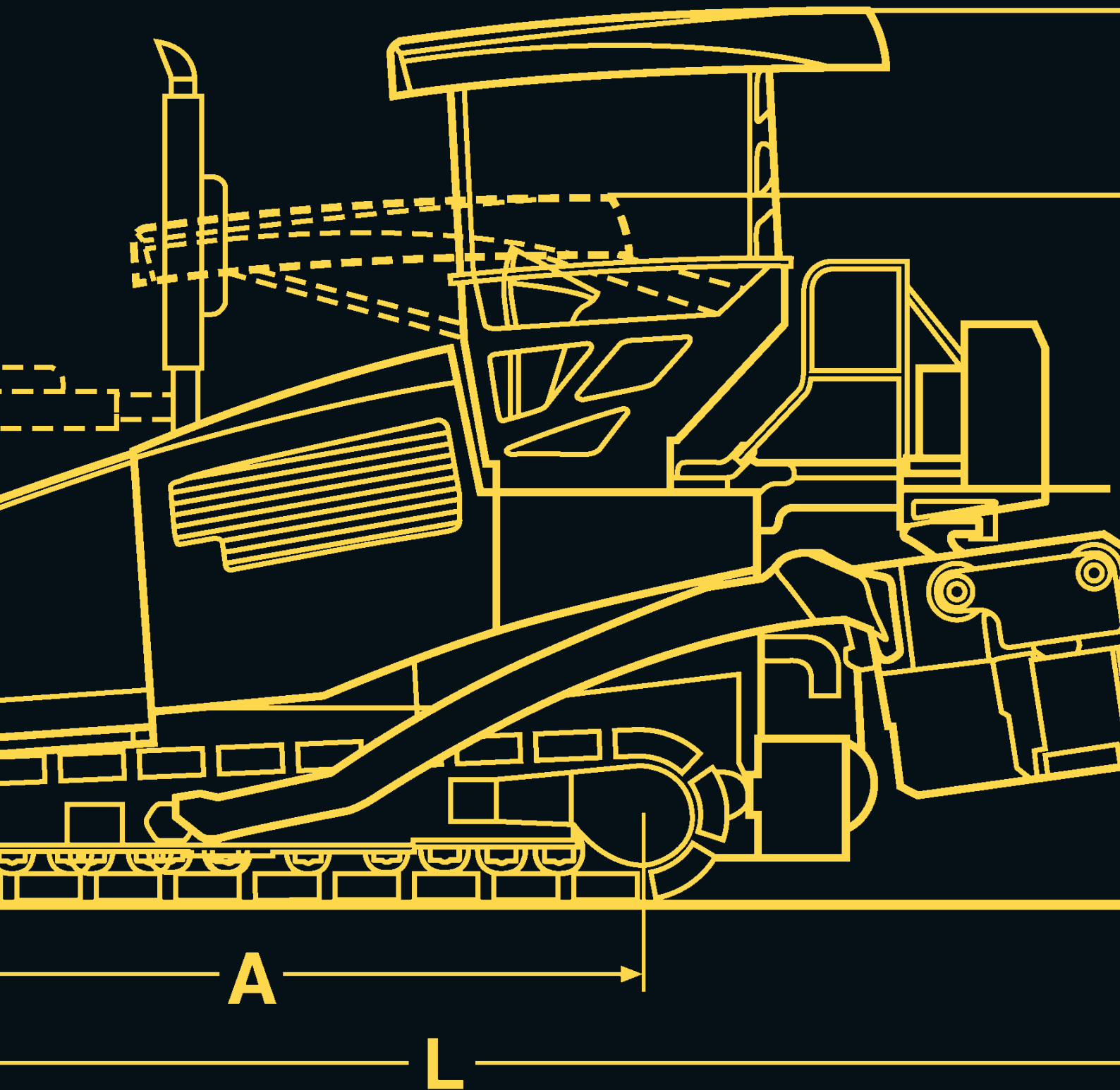

BORN FOR THE ROAD.

THE NEW PAVERS WITH BOMAG DNA.





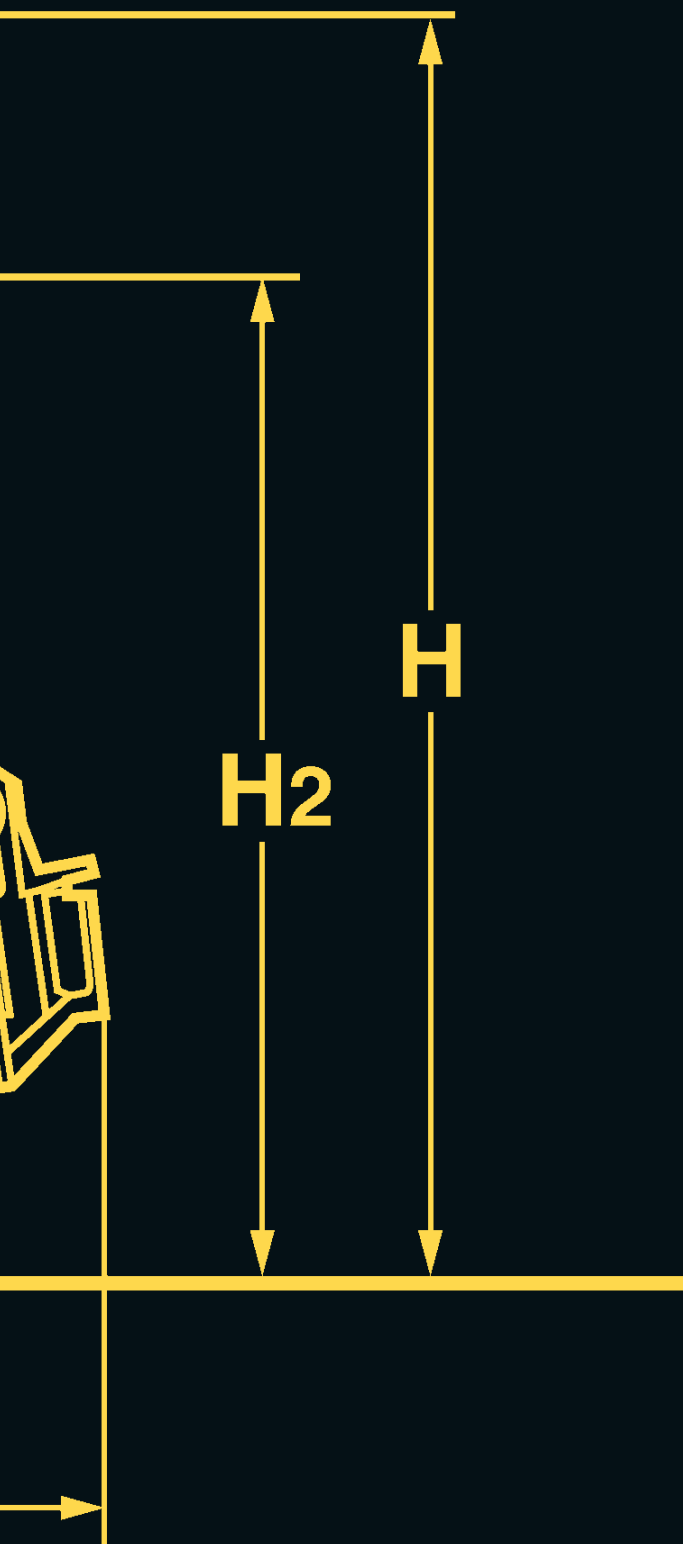

CONTENTS

4	Know-how since 1957
6	Paver range
8	High tech at a glance
10	MAGMALIFE
12	QUICK COUPLING
14	ECOMODE
16	SIDEVIEW
18	Maintenance concept
19	Fascination of technology
20	Cost analysis
22	BF 223 series
23	BF 300 series
24	BF 600 / BF 700 series
26	BF 800 / BF 900 series
28	Optional equipment
30	In operation
32	Technical data
34	Outlook

MILLIONS OF KILOMETRES BEAR OUR SIGNATURE.

You build the finest roads so we can all make the quickest progress. And to ensure your rapid progress, we build the best machines. As a member of the leading international FAYAT group, we supply machines for all areas of road construction – from soil compactors via cold planters and recyclers, from asphalt rollers to road pavers. For over 60 years, the history of our company has been synonymous with the history of road construction.

With our accumulated know-how, we are an innovation driver that sets the pace for an entire industry. BOMAG has developed a huge number of technologies, from systems for measuring and controlling compaction, like Economizer and Asphalt Manager, up to technologies for reducing operating costs, like ECOMODE and the most effective screed heating in the mar-

ket: MAGMALIFE. We offer solutions for a wide range of applications.

Our global network of experts and partners in over 120 countries supports you comprehensively, from the configuration of the machines to providing solutions for the most challenging of tasks.

We owe our innovative strength to our more than 2,000 employees worldwide, their commitment and their unique wealth of experience. A source of know-how which has propelled us to worldwide market leadership in this sector. The reason for this is our unconditional commitment to quality: in product development, the qualification of our employees, and service that guarantees optimal on site support.



MAXIMUM EFFICIENCY RUNS IN THE FAMILY.



HIGHWAY PAVER
BF 900 and BF 800

UNIVERSAL PAVER
BF 700 and BF 600

Road construction is a complex task. That's why every BOMAG paver is systematically designed for efficiency – regardless of the class and whether it is a wheel or chain version. This applies as much to the lower fuel consumption as to fast operational readiness and excellent pre-compaction. Developed and optimised by engineers, who can draw

upon half a century of experience, particularly in respect of efficient road construction. Every machine leaves our factory with the highest possible level of reliability. Another reason why selecting BOMAG ensures an investment that pays off for a long time.



CITY PAVER
BF 300

MINI PAVER
BF 223

GOOD JOB ESPECIALLY THE DETAILS.

WHAT MAKES OUR PAVERS UNIQUE:



PERFECT VISIBILITY

With the slidable operator's stand and SIDEVIEW function.



LONGEST SERVICE LIFE

With the MAGMALIFE principle, heating rods cast in aluminium.



FASTEST POSSIBLE HEAT-UP TIMES

With MAGMALIFE, the innovative screed technology.





OPTIMAL ERGONOMICS

With the patented SIDEVIEW operating concept.



EXEMPLARY EFFICIENCY

With ECOMODE, the intelligent engine and hydraulics management system.



SHORTER SETUP TIMES

With QUICK COUPLING, the user-friendly quick attachment system.





Speed is not a question of sorcery, but the result of creative, user-oriented engineering. The new MAGMALIFE screed heating is ready for operation three times faster than conventional systems.

TYPICAL BOMAG: MAGMALIFE.

A PAVER THAT HEATS UP QUICKER, FINISHES SOONER.

High temperatures are absolutely crucial in asphalt construction. With MAGMALIFE we have redefined screed heating. All the heating rods are cast into one aluminium block. Because of the metal's excellent thermal conductivity, the heat-up time is significantly shorter so the paver and team are ready for operation more quickly.

- Heat-up period and even temperature distribution in just 20 minutes
- Increased corrosion protection
- 2 years guarantee on aluminium heating plates
- Generously dimensioned generator
- Simple, intuitive operation
- Independent side plate heating

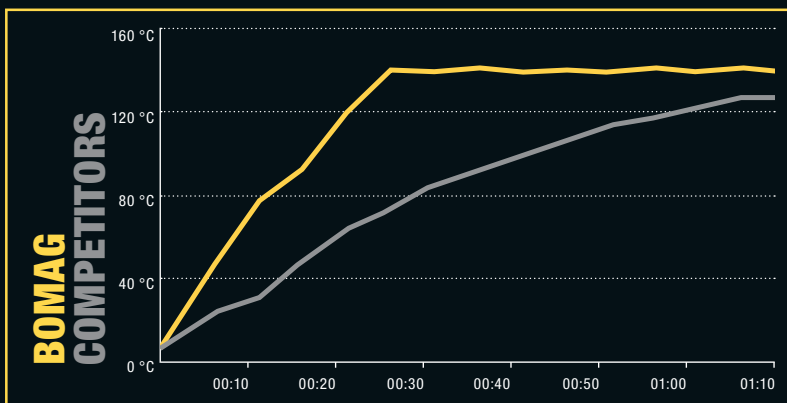

BOMAG compared to conventional electric screeds.

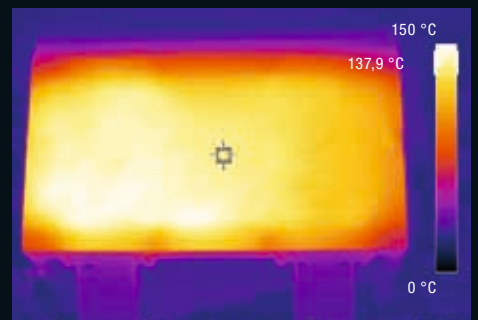

Optimal temperature distribution.



Perfectly protected: Cast-in heating elements.



Surprisingly simple: Heating system with monitored heating circuits.



Practical efficiency best describes our QUICK COUPLING technology. It provides a prototypical illustration of how our engineers think: brilliantly simple rather than simply complicated. And that's what counts on site.



TYPICAL BOMAG: QUICK COUPLING.

EQUIPPED WITH SHORT SET-UP TIMES.

Fast, simple, perfect: that's what BOMAG's QUICK COUPLING stands for. A smart quick-attachment system that allows screed extension without fiddly screw fastenings. Result: Shorter retrofitting times and significant cost reductions.

- Hooking the attachments into dedicated guides
- Use of sliding couplings
- No lateral screed support required
- Greatest possible flexibility for all laying widths

COST COMPARISON SCREED EXTENSION BOMAG vs. COMPETITORS

TIME COMPARISON



BOMAG
Assembly and dismantling
with QUICK COUPLING
1.5 h x 2 persons



COMPETITORS
Assembly and dismantling
without QUICK COUPLING
3 h x 2 persons

COST COMPARISON

€ 68,400

€ 136,800

E.g. 76 fitting and dismantling operations per year. Wage costs € 60/hour
Total 5 years service life.

50% TOTAL SAVINGS



Maximum flexibility: few parts, quickly assembled.

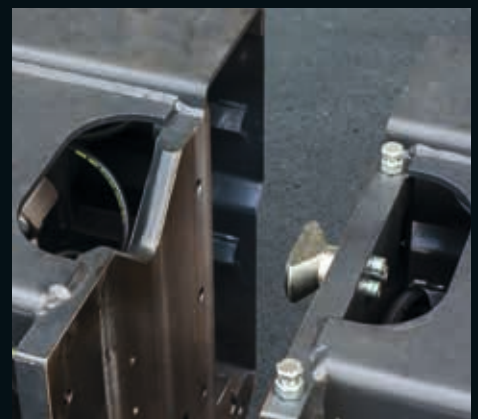

Brilliantly simple: The receptacle of the QUICK COUPLING system.



TYPICAL BOMAG: ECOMODE.

SMARTER UNDER THE HOOD.

With the new ECOMODE, BOMAG offers its customers surely the most economical road paver on the market. It has an active engine and hydraulics management system which saves up to 20% fuel, significantly reduces noise and has a lower negative impact on the environment. Even in the rough surroundings of a construction site, intelligent electronics pay off.

- Controlled engine speed saves fuel and ensures a quieter working environment
- Demand-driven hydraulics deliver the exact power that is required
- Hydraulically controlled fans additionally reduce fuel consumption and noise emissions

Experience has shown that 80% of daily work can be done in the cost-efficient ECOMODE. Only when more power is required, do the sensors immediately adjust the engine speed.





Powerful and economic: Engines in exhaust classifications Tier 3 and Tier 4 final.

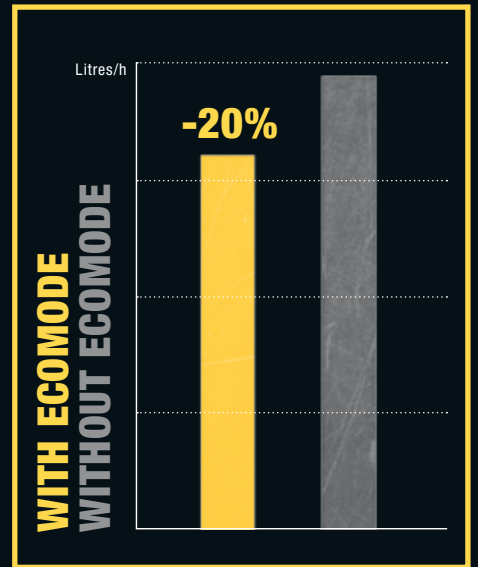

Efficiency at the flick of a switch: ECOMODE.

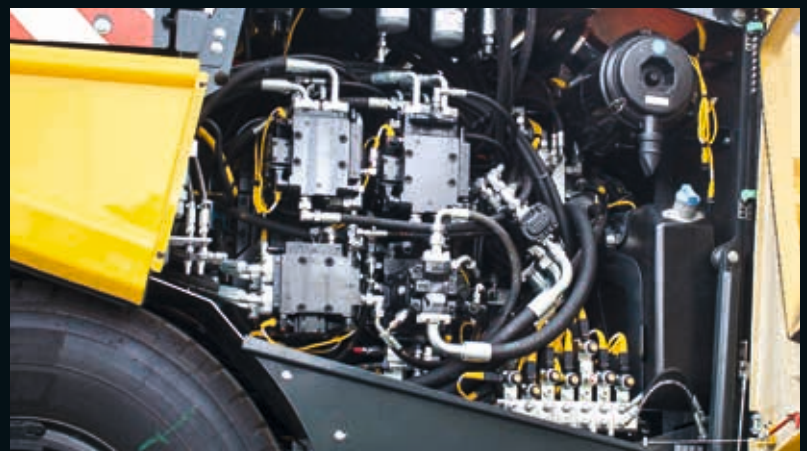

Reliable: demand-driven hydraulics deliver the exact power that is required.





TYPICAL BOMAG: SIDEVIEW.

STEERS LEFT, STEERS RIGHT, BUT NEVER DISTRACTS.

In developing the operator's stand of the latest paver generation, our engineers focussed on comfort, ergonomics and operability. Their solution: the patented BOMAG SIDEVIEW system.

The operating console and seat form a variably adjustable unit. The entire control stand can be shifted to the left and right with a maximum overhang of 60 cm. Then you can focus on what matters most in the driver's cab: optimal visibility of the edge of the machine, the hopper, the auger and the screed.

Every function can be selected directly on the operating consoles. All the switches are arranged logically and ergonomically. Our road pavers can be operated after just a brief introduction without the need for time consuming training courses.



Everything in view: good visibility in the entire working area.

Road construction is precision work. For this reason, we developed our pavers with the operators in mind: How can the machine make their job easier? The result is a driver's cab which, thanks to SIDEVIEW technology, enables the operator to keep an eye on everything important.



The right position for every situation: the comfortable operator's cab.



MAINTENANCE WITH A CONCEPT.

SIMPLE IS SIMPLY THE BEST.

The maintenance of our road pavers is as simple as their operation. As every function is controlled by its own switch, every switch can also be replaced separately. The engine compartment with the hydraulic systems is easily accessible from every side and all the filters can be reached comfortably and centrally

from one side. Good ideas, such as the fully-automated central lubrication system, contribute to the remarkably long maintenance intervals of our pavers. To keep any downtimes as short as possible, we offer carefully selected maintenance and emergency kits.



All you need for maintenance: BOMAG service kits.



Generous: maintenance access.



Fast and competent: our on-site service.



All you need in case of emergency: BOMAG emergency kits.



Peace and quiet: Low noise level as a standard.



Everything shipshape: ample storage room on board our road pavers.



Completely level: long levelling plates for an optimal surface structure.

SPECIAL SOLUTIONS EX WORKS.

MAKING HARD WORK EASIER.

Ideas are always in demand. Especially in road construction and especially when they add user value. In this respect, our engineers' ingenuity is unsurpassed.

The low noise level of the powerful engines protects the operating team and the ample storage room on board makes it easy to keep things organised during operation. Generously dimensioned levelling plates coupled with

the high weight of our high-performance screed enable a perfect work result with excellent smoothness, optimal surface structure and the highest level of pre-compaction.

Consistent quality management and unique technical systems, such as MAGMALIFE, QUICK COUPLING and ECOMODE also make the BOMAG pavers unbeatable in terms of cost. The total cost of ownership (TCO) – the sum of all costs incurred during operation – shows this impressively.



TOTAL COST OF OWNERSHIP (TCO).

EVERY OPERATION SAVES COSTS.

BOMAG road pavers not only build the best roads. They also look best on the balance sheet. Extensive TCO analyses have shown that the lifecycle costs are significantly lower than those of competitors.

You make savings of 6%, for example, on routine maintenance costs* and 17% on fuel. And when preparing for operation, you can reduce costs for heating-up by 60% and for extending the screeds by 48%. All in all, you can achieve at least five-figure euro savings on average per year. Projected over the entire life cycle, this can result in savings of well over 100,000 euros! Innovative BOMAG technology creates quality and protects the environment and your wallet in equal measures.

TOTAL COMPARISON TCO

Repair and maintenance costs¹



Fuel costs²



Heat-up time³

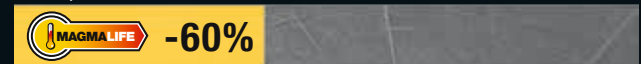

Extension⁴

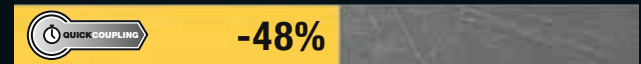

Total costs



*Central European site conditions, based on model BF 700, service life 5 years, 1,000 operating hours/year.

1) No replacement of heating elements every 2 years.

Based on: Service costs: € 68/h, Distance to service base: 160km

2) Consumption: 9.5 litres/h instead of 11.4 litres/h, heating phase up to 10 min. shorter (Fuel: € 1.31/l)

3) Heating phase up to 10 min. shorter

4) 50% shorter installation time with QUICK COUPLING system.

Based on: 4 changeovers/month, screed width: 8 metres, 2 workers

With a weight of just 5 tons and a compact design, the **BF 223** is particularly economical when constructing cycle- and pedestrian paths, or for landscape gardening.



MINI PAVER BF 223 / CITY PAVER BF 300 C:

EXCELLENT ON SMALL CONSTRUCTION SITES.

Compact, strong, reliable: Our small machines know their trade just as well as their big brothers and are characterized especially by their flexibility. Ideal for use on confined construction sites.

BF 223

- Intuitive operation concept and thus fast handling
- Electrically heated hydraulic screed with 1.4–2.6 m laying width
- Compact dimensions for working in confined spaces
- Foldable operator's stand for easy transportation



Flexible use thanks to the compact design.



The **BF 300** is an 8.5 tonne machine that is ideally suited for inner-city redevelopments. However, its versatility also makes it highly suitable for rural path construction.

BF 300

- Powerful yet economical: the 55 kw engine in tandem with ECOMODE engine management
- MAGMALIFE heating elements for a longer service life and even heat distribution
- Especially user-friendly with the BOMAG SIDEVIEW system
- Laying widths of up to 5 metres possible



Impact-free docking thanks to 22 dampened bumper rollers.



UNIVERSAL PAVERS BF 600 / BF 700:

IN THEIR CLASS A CLASS OF THEIR OWN.

These all-rounders with their optimal combination of productivity and flexibility have everything you need for high-quality and efficient road construction.

- ECOMODE regulates the hydraulics according to the required power
- Reduction of fuel consumption and noise emissions through intelligent motor management
- Reliable material distribution – even with large laying widths
- MAGMALIFE enables faster heat-up times and homogenous heat distribution by means of aluminium plates
- Shorter set-up times with QUICK COUPLING – the quick attachment system
- Maximum flexibility through a variety of laying widths



The **BF 600** comes equipped with 116 kW, a weight of 19.8 t and a maximum laying capacity of 600 t/h, the **BF 700** boasts 128 kW, a weight of 20.2 t and a laying capacity of 700 t/h. Both machines have a basic screed width of between 2.5–5 metres or 3–6 metres.



The all-rounder: from forest roads to motorways.



Optimal material distribution: the generously dimensioned auger diameter.



Dampened bumper rollers: hydraulically adjustable with a pendulum bearing.



HIGHWAY PAVER BF 800 / BF 900: **EVEN BUILDS ROADS FOR AEROPLANES.**

Our heavy weight machines for heavy weight projects. Used wherever high laying performance is required: for example on motorways or even on the runway network of a major airport.

- Highest pre-compaction of up to 95% by means of an infinite vibration- and tamper frequency
- Longest crawler tracks guarantee best traction
- The innovative BOMAG systems ECOMODE, MAGMALIFE, QUICK COUPLING and SIDEVIEW ensure optimal safety and cost-efficiency
- Very long levelling plates for perfect asphalt evenness
- Proportional control of the augers and conveyor belts by means of ultrasonic sensors
- Load control system (L.C.S.) for the screed
- Easy and safe transportation through the hydraulically lowerable roof and fast screed fixing for shipment



Incorrect operation impossible: the operating console.

The **BF 800** comes equipped with 135 kW, a weight of 21.3 t and a laying capacity of 800 t/h. Its big brother **BF 900** offers 160 kW, 21.5 t weight and 900 t/h laying capacity. Both can be extended to a working width of 10 metres.



Smooth material flow: the reversible scraper belt.



Night construction site at the airport: best laying results under time pressure.

OPTIONAL EQUIPMENT.

WE BUILD THE MACHINE ACCORDING TO YOUR WISHES.

A BOMAG road paver leaves the factory equipped with everything it needs for operation. As a customer, however, you have plenty of scope to create your idea of the perfect machine.



Hydraulically slidable SIDEVIEW platform

Especially comfortable: With this "luxury kit" you can automatically move the control stand and raise or lower the roof with an electric motor.

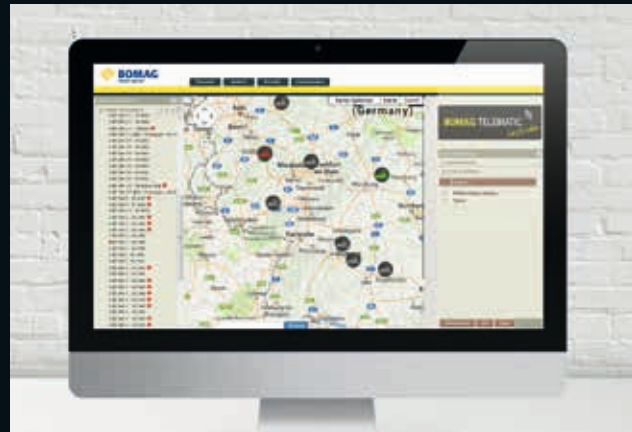

BOMAG TELEMATIC

Especially informative: You know where your machine is at all times, how it is being utilised, and when the next service is due.



Ventilation system

Especially fresh: The ventilation system extracts asphalt fumes from the augers and discharges them through the exhaust on the roof.



Electrically heated screed side plates

Especially clean: These plates prevent bitumen sticking to the cold side plates of the screed and leaving unwanted traces on the asphalt.



Pump for the lubrication system

Especially reliable: The fully-automated, centrally located pump supplies lubricants to the basic screed, conveyor belt and auger.



Special paint finish

Especially appealing: You can order your paver directly from the factory with the hopper wings, doors and hard roof painted in your company colours.



Power-Moon

Especially bright: If you would like to further increase the high illumination provided as standard, we can provide an additional balloon together with mounting materials.



MOBA levelling systems

Especially sensitive: Various levelling systems providing height and lateral sensing activated by 28 sensors are optionally available ex works.

OUR GOOD REPUTATION IS KNOWN AROUND THE WORLD.

Quality quickly becomes evident. Everywhere. It's no surprise, therefore, that our machines are in use in major projects around the globe. Here, for example, the construction of a motorway from Beijing to central Mongolia. A truly mammoth task which, when completed, will consist of more than 3,700 kilometres of challenging road

construction. Here, our pavers have to deal with a roadway width of 19.8 m. The picture shows two BF 800 C with the S 600 TV screed, as well as the single drum rollers BW 203 and BW 25 RH. We are proud that machines only built by us have earned the trust of companies all over the world.







	BF 223 C	BF 300 C	BF 300 P	BF 600 C-2
Output	200 t/h	300 t/h	300 t/h	600 t/h
Weight	5.1 t	8.5 t	8 t	19.5 t
Hopper size	2.8 m ³	4.8 m ³	4.8 m ³	7 m ³
Engine	37 kW Perkins	55 kW Kubota	55.4 kW Kubota	115 kW Deutz 113 kW Mercedes
Exhaust classification	Tier 3	Tier 3 Tier 4f	Tier 3 Tier 4f	Tier 3 Tier 4f

SCREED

Screed type	HF	S 340-2 TV	S 340-2 TV	S 500 TV
Compaction unit	Vibration	Tamper Vibration	Tamper Vibration	Tamper Vibration
Standard laying width	1.4–2.6 m	1.7–3.4 m	1.7–3.4 m	2.5–5 m
Maximum laying width	4 m	5 m	4.4 m	8 m

Screed type		S 340-2 V	S 340-2 V	S 600 TV
Compaction unit		Vibration	Vibration	Tamper Vibration
Standard laying width		1.7–3.4 m	1.7–3.4 m	3–6 m
Maximum laying width		5 m	4.4 m	8 m

**BF 600 P-2****BF 700 C-2****BF 800 C****BF 800 P****BF 800 SOIL****BF 900 C**

600 t/h

700 t/h

800 t/h

800 t/h

800 t/h

900 t/h

18.5 t

19.5 t

21.3 t

20.3 t

21.3 t

21.5 t

7 m³7 m³7.2 m³7.2 m³7.2 m³7.2 m³128 kW
Mercedes128 kW Deutz
128 kW
Mercedes135 kW Deutz
140 kW Deutz135 kW Deutz
140 kW Deutz135 kW Deutz
140 kW Deutz

160 kW Deutz

Tier 4f

Tier 3
Tier 4fTier 3
Tier 4iTier 3
Tier 4iTier 3
Tier 4iTier 3
Tier 4i

S 500 TV

S 500 TV

S 500 TV

S 500 TV

S 500 TV

S 500 TV

Tamper
VibrationTamper
VibrationTamper
VibrationTamper
VibrationTamper
VibrationTamper
Vibration

2.5–5 m

2.5–5 m

2.5–5 m

2.5–5 m

2.5–5 m

2.5–5 m

7.5 m

9 m

9 m

9 m

9 m

9 m

S 600 TV

S 600 TV

S 600 TV

S 600 TV

S 600 TV

S 600 TV

Tamper
VibrationTamper
VibrationTamper
VibrationTamper
VibrationTamper
VibrationTamper
Vibration

3–6 m

3–6 m

3–6 m

3–6 m

3–6 m

3–6 m

7.5 m

9 m

10 m

9 m

10 m

10 m

Technical modifications reserved. Machines may be shown with options.



SUCCESS IS THE RESULT OF HARD WORK. AND BETTER TOOLS.

We are committed to the highest technology standards. Products which do not compromise on quality and cost-efficiency. In future, we will continue to do our utmost to pave your way. With a flexible service concept where people

play an important role. With machines which can be operated easily and logically. And always with new ideas to make your construction work easier and guarantee optimal results. Success comes from teamwork – we're ready!

Head Office / Hauptsitz:

BOMAG

Hellerwald
56154 Boppard
GERMANY
Tel. +49 6742 100-0
Fax +49 6742 3090
info@bomag.com

**BOMAG Maschinen-
handelsgesellschaft m.b.H.**

Porschestraße 9
1230 Wien
AUSTRIA
Tel. +43 1 69040-0
Fax +43 1 69040-20
austria@bomag.com

BOMAG MARINI EQUIPAMENTOS LTDA.

Rua Comendador Clemente Cifali, 530
Distrito Industrial Ritter
Cachoeirinha – RS
BRAZIL
ZIP code 94935-225
Tel. +55 51 2125-6677
Fax +55 51 3470-6220
brasil@bomag.com

BOMAG (CANADA), INC.

3455 Semenyk Court
Mississauga, Ontario L5C 4P9
CANADA
Tel. +1 905 361 9961
Fax +1 905 361 9962
canada@bomag.com

BOMAG (CHINA)

Compaction Machinery Co. Ltd.
No. 2808 West Huancheng Road
Shanghai Comprehensive
Industrial Zone (Fengxian)
Shanghai 201401
CHINA
Tel. +86 21 33655566
Fax +86 21 33655508
china@bomag.com

BOMA Equipment

Hong Kong LTD

Room 1003, 10/F Cham Centre
700, Castle Peak Road
Kowloon
HONG KONG
Tel. +852 2721 6363
Fax +852 2721 3212
bomahk@bomag.com

BOMAG France S.A.S.

2, avenue du Général de Gaulle
91170 Viry-Châtillon
FRANCE
Tel. +33 1 69578600
Fax +33 1 69962660
france@bomag.com

BOMAG (GREAT BRITAIN), LTD.

Sheldon Way
Larkfield, Aylesford
Kent ME20 6SE
GREAT BRITAIN
Tel. +44 1622 716611
Fax +44 1622 710233
gb@bomag.com

BOMAG Italia Srl.

Via Roma 50
48011 Alfonsine
ITALY
Tel. +39 0544 864235
Fax +39 0544-864367
italy@bomag.com

FAYAT BOMAG Polska Sp. z o.o.

Ul. Szyszkowa 52
02-285 Warszawa
POLAND
Tel. +48 22 482 04 00
Fax +48 22 482 04 01
poland@bomag.com

FAYAT BOMAG RUS OOO

141400, RF, Moscow region
Khimki, Klayazma block, h. 1-g
RUSSIA
Tel. +7 (495) 287 92 90
Fax +7 (495) 287 92 91
russia@bomag.com

BOMAG GmbH

300 Beach Road
The Concourse, #18-06
Singapore 199555
SINGAPORE
Tel. +65 6 294 1277
Fax +65 6 294 1377
singapore@bomag.com

BOMAG Americas, Inc.

125 Blue Granite Parkway
Ridgeway SC 29130
U.S.A.
Tel. +1 803 3370700
Fax +1 803 3370800
usa@bomag.com